

# S12A

12.1" Full IP 67 Panel PC

**Full IP 67**  
Up to 1 meter of submersion

## Features:

- 12.1" 1300 nits super high brightness LED available
- IP 67 (NEMA 6) fully-enclosed aluminum die cast enclosure and IP 67 waterproof lockable I/O
- Fanless system integrated with Intel® Atom™ N270 1.6G processor for ultra low voltage
- Supports one 2.0 GB (max.) 400/533 MHz DDR2 SO-DIMM
- Built-in internal Wi-Fi antenna supports 802.11b/g/n high standard
- CAN-bus interface for automotive applications
- Ambient light sensor detects ambient light for automated screen adjustments to optimize viewing (Advanced Deep Dimming to Black for sunlight readable model)
- Standard VESA 75/100 compliance



## Rugged Panel PC with Fanless Intel® Atom™ Processor

The fanless intelligent display computer, S12A, uses a 45 nm Intel® Atom™ processor with up to 1.6 GHz frequency and can be used in harsh and safety-critical applications in transport, avionics, engineering or industrial automation.

Better graphics performance is excellent for kiosk, self-service terminal, and digital signage applications.

Evaluating 3D mark performance with different generation CPU and chipset combination, Intel® Atom™ processor is the best solution for low power consumption and better graphics performance choice.

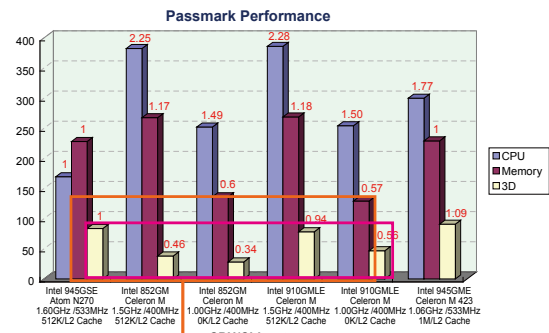

Memory Performance 40% better than Intel 915GMEL/1GZ & 852GM/1GZ  
Graphic Performance 40% better than Intel 910GMLC/1GZ, 65% better than 852GM/1GZ

## Sunlight Readable

### ■ Super High Brightness

S12ASR (Sunlight Readable Model) has greatly improved luminance through edge lighting to achieve super high brightness (up to 1000 cd/m<sup>2</sup>).

### ■ Low Reflection through AR (Anti-Reflection) Technology

Outdoor applications in daylight or other bright environments require technology that can suppress surface reflection. S12ASR sunlight readable model offers special AR (anti-reflection) surface treatment to prevent reflection, which ensures excellent visibility in daylight conditions.



**Super High Brightness: 1000 nits**  
**High Contrast: 700:1**  
**Wide Viewing Angle: 60/60 (R/L) 45/75 (U/D)**

## IP 67 Fully-Enclosed Design

The S12A is front sealed and tested in the certified house chamber under UL's Witnessed Test Data Program (TDP). IEI follows IP 67 standard testing procedures. This full IP 67 touch monitor provides full IP 67 protection including connectors, cables and screen.

### [ IP 67 ] Dust-Tight

**First Digit** The first digit indicates the level of protection that the enclosure provides against access to hazardous parts

Level		Effective Against
6		No ingress of dust; complete protection against contact

### [ IP 67 ] Temporary immersion under water 1m

**Second Digit** Protection of the equipment inside the enclosure against harmful ingress of water

Level		Effective Against
7		Ingress of water in harmful quantity shall not be possible when the enclosure is immersed in water under defined conditions of pressure and time (up to 1m of submersion)

### Sealing enclosure with all sides of IP 67 !



### ■ IP6X Test

#### • Test for protection against dust

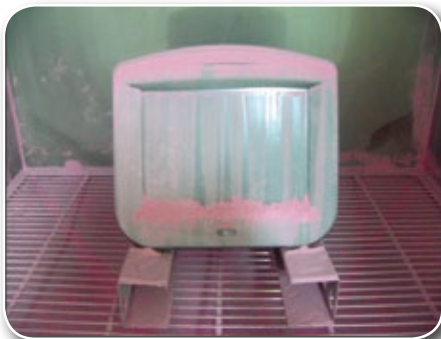

### ■ IPX7 Test



#### • Test for protection against water

Protected against the effects of temporary immersion between 15 cm and 1m. Duration of test is 30 minutes



#### • Air Flow Test

Air pressure measurement is used as the IP 67 test method, the air flow tester is capable of detecting leaks in product and evaluates the pass/fail status of the watertight system.

## Uninterrupted Wireless Connection

The S12A series features high speed Wi-Fi IEEE 802.n protocol which builds on previous 802 standards by adding multiple-input multiple-output (MIMO) and 40 MHz operation to the physical (PHY) layer. MIMO uses multiple transmitter and receiver antennas to improve system performance.



27 times faster data transfer rate compared to 802.11b

Protocol	Freq. (GHz)	Thru. (Mbit/s)	Data (Mbit/s)	Range indoor (m)	Range outdoor (m)
802.11a	5 GHz	23	54 Mbit/s	~35	~120
b	2.4 GHz	4.3	11 Mbit/s	~38	~140
g	2.4 GHz	19	54 Mbit/s	~38	~140
n	5 GHz and/or 2.4 GHz	74	300 Mbit/s (2 streams)	~70	~250

802.11b/g Wi-Fi, which gives you up to broadband-speed browsing and connectivity, compared to traditional wired LAN.

The benefits here:

- Simple configuration
- Without hinders worker movement
- Without lessens man-hour productivity
- Without additional purchase of proprietary cables for specific devices
- Without the barrier to space

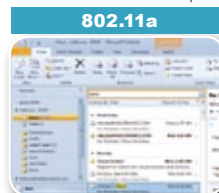

Access to email, instant image and the Internet

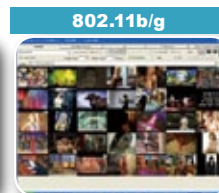

Streaming music  
Streaming video



VoIP/Gaming/NAS

802.11b/g/n ready with invisible antenna



#### Benefits

- \* Half the size of Mini-PCI
- \* Higher bandwidth interface
- \* Rigid mechanical spec.



PCIe Mini

Mini PCI

30 mm

30 mm

30 mm

30 mm

30 mm

30 mm

30 mm

30 mm

30 mm

30 mm

30 mm

30 mm

30 mm

30 mm

## Ambient Light Sensor

The S12A built-in ambient light sensor automatically detects the amount of light in the viewing environment and auto-adjusts the brightness of the screen.

**Benefits:**

- Provides comfortable viewing and prevents eye strain
- Power saving
- Extended lamp life



**Day Mode:**  
Adjust to maximum 1000 nits  
Sunlight Readable automatically

Panel brightness auto-adjustment depends on the ambient light amount to save the system power

**Night Mode:**  
Adjust to acceptable brightness automatically in an insufficient light ambient

## CAN-bus Automotive Applications

The S12A is equipped with automotive applied CAN-bus interface. The Control Area Network (CAN) is a serial bus system, originally developed by Bosch for use in automobiles, and now is increasingly being used for control in industrial and automotive applications

### Controller Area Network

- 1Mb/s data rate
- High reliability bus
- CAN is an open standard with many variants
- Capable of providing real-time communication.

### ■ CAN in cars and truck engine

- Networking controllers for engine timing, transmission, chassis and brakes.
- Networking components of chassis electronics and electronics which make the vehicle more comfortable. Examples of such multiplex applications are lighting control, air-conditioning, central locking and seat and mirror adjustment.

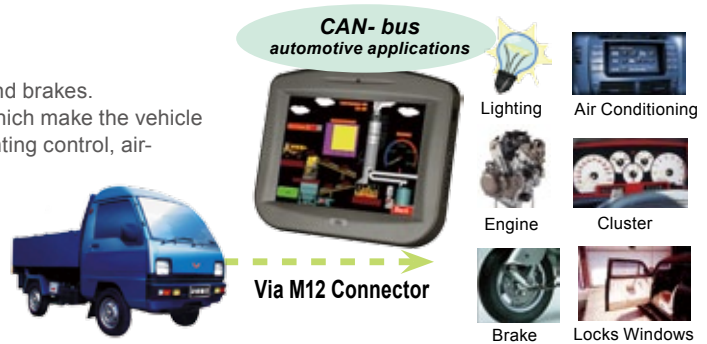

### Other Application Fields:



## Reliable Die-Cast Aluminum Chassis

These ruggedized LCD products are designed for high reliability, shock and vibration tolerance, survival of high temperature, and corrosive environments. External materials like dust/water can be very destructive to any type of equipment over time.

### ■ Fanless and Completely Sealed Strong Housing

Sealed housing strictly prevents water invasion while the rugged die-cast aluminum enclosure eliminates the need for a fan as a heat dissipation device.

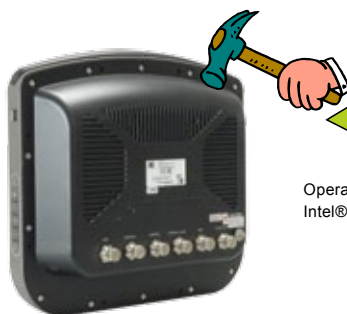

Operating Temperature: -10°C~50°C With on-board Intel® Atom™ Processor N270 1.6GHz

### ■ Rigorous Shock/Vibration Test

Compliant with MIL-STD-810F shock and vibration protection, as well as offering IP 67 water and dust proof front panel protection.

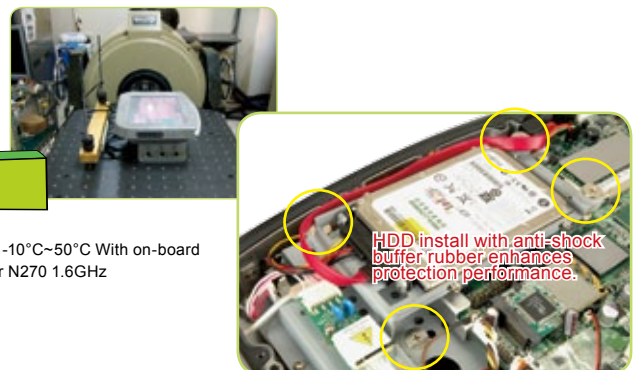

HDD install with anti-shock buffer rubber enhances protection performance.

# Fully Integrated I/O

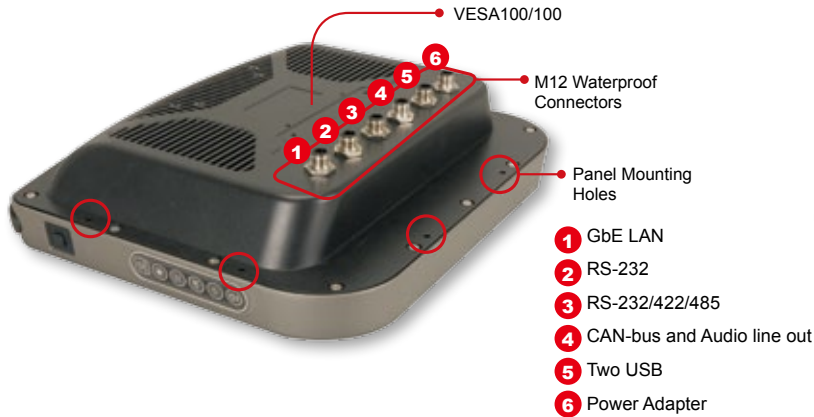

## Specifications



Model		S12A-N270	S12ASR-N270
Display	LCD Size	12.1"	
	Max Resolution	1024 x 768	
	Brightness (cd/m <sup>2</sup> )	500	1300
	Contrast Ratio	700:1	600:1
	LCD Color	16.2M	16.7M
	Pixel Pitch (mm)	0.3075 (H) x 0.3075 (V)	0.240 (H) x 0.240 (V)
	Viewing Angle (H-V)	160°/160°	160°/140°
	Backlight MTBF (hrs)	50000	100000
Touch	Touch Screen	Resistive Type 5-Wire with RS-232 interface	
	Touch Controller	PENMOUNT 6000	
Motherboard	CPU	Intel® Atom™ N270 1.6GHz CPU	
	Chipset	Intel® 945GSE + ICH7M	Intel® 945GSE + ICH7M
	RAM	One 400/533MHz DDR2 SO-DIMM (Max. 2GB)	
	Ethernet	Realtek RTL8111CP PCIe GbE controller	
	Audio Codec	Realtek ALC892 audio codec	
I/O Ports and Switches		1 x 5-pin M12 connector for Power Adapter	
		1 x 8-pin M12 connector for two USB	
		1 x 5-pin M12 connector for CAN-bus and Audio line out	
		1 x 8-pin M12 connector for UART RS-232/422/485	
		1 x 8-pin M12 connector for UART RS-232	
		1 x 8-pin M12 connector for GbE LAN	
Drive Bay	HDD Driver Bay	1 x 2.5" SATA HDD Bay	
	SSD	CF Type II	
Expansion Slot		1 x Wireless LAN Module (802.11 b/g/n) (internal PCIe Mini card interface)	
Physical	Front Panel Construction	Aluminum	
	Chassis Construction	Heavy-duty steel	
	Mounting	Panel, Rack, Stand and Arm VESA 100mm x 100mm	
	Front Panel Color	Silver (Pantone 8403C)	
	Dimensions (WxHxD) (mm)	345.3 x 300.4 x 77	
	Net/Gross Weight	4.2 Kg / 5.3 Kg	
Environment	Operating Temperature (°C)	-10°C ~50°C	-10°C ~50°C
	Storage Temperature (°C)	-20°C ~70°C	-20°C ~70°C
	Vibration	5~17Hz, 0.1" double amplitude displacement 17~640Hz, 1.5G acceleration peak to peak	
	Shock	10G acceleration part to part (11ms)	
Optional Power Supply		P/N: 63000-CLG60121C-RS - Input: 90VAC~264VAC, 50/60Hz - M12 waterproof connector 5P	- 60W Power Adapter - Output: 12VDC
Power Requirement		9~28VDC	
Front Panel Protection		IP 67 Compliant	
Power Consumption		33W	51W
Certificate		Meets CE, FCC, DNV	

**S12A**  
Dimensions (Unit: mm)

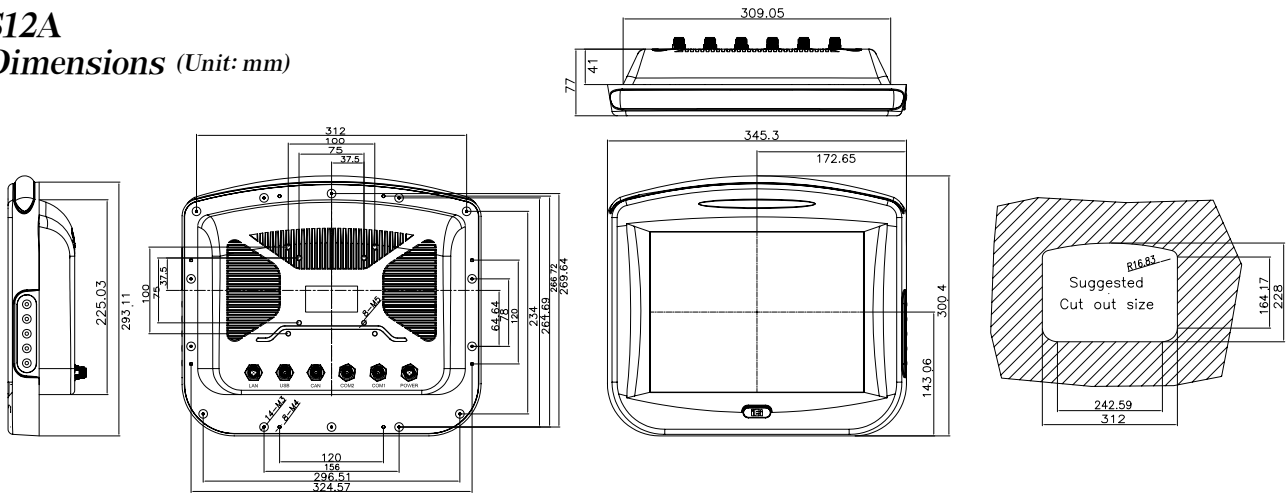

**Ordering Information**

Part No.	Description
S12A/R/1/32-X-R30	12.1" 500 cd/m <sup>2</sup> IP67 panel PC with Intel® Atom™ N270 CPU 1.6GHz, 802.11 b/g/n wireless module, touch screen, 1GB DDR2 553 MHz, M12 connectors and 320GB SATA HDD with Windows XP Embedded operating system, R30
S12A/R/1/4-L-R30	12.1" 500 cd/m <sup>2</sup> IP67 panel PC with Intel® Atom™ N270 CPU 1.6GHz, 802.11 b/g/n wireless module, touch screen, 1GB DDR2 553 MHz, M12 connectors and 4GB compact flash with LINUX operating system, R30
S12A/R/1/32-L-R30	12.1" 500 cd/m <sup>2</sup> IP67 panel PC with Intel® Atom™ N270 CPU 1.6GHz, 802.11 b/g/n wireless module, touch screen, 1GB DDR2 553 MHz, M12 connectors and 320GB SATA HDD with LINUX operating system, R30
S12A/R/1/1-C6-R30	12.1" 500 cd/m <sup>2</sup> IP67 panel PC with Intel® Atom™ N270, CPU 1.6GHz, 802.11 b/g/n wireless module, touch screen, 1GB DDR2 553 MHz, M12 connectors and 1GB compact flash with Windows CE 6.0 operating system, R30
S12A/R/1/4-X-R30	12.1" 500 cd/m <sup>2</sup> IP67 panel PC with Intel® Atom™ N270 CPU 1.6GHz, 802.11 b/g/n wireless module, touch screen, 1GB DDR2 553 MHz, M12 connectors and 4GB compact flash with Windows XP Embedded operating system, R30
S12ASR/R/1/1-C6-R40	12.1" 1300 cd/m <sup>2</sup> IP67 panel PC with Intel® Atom™ N270, CPU 1.6GHz, 802.11 b/g/n wireless module, touch screen, 1GB DDR2 553 MHz, M12 connectors and 1GB compact flash with Windows CE 6.0 operating system, R40
S12ASR/R/1/4-X-R40	12.1" 1300 cd/m <sup>2</sup> IP67 panel PC with Intel® Atom™ N270 CPU 1.6GHz, 802.11 b/g/n wireless module, touch screen, 1GB DDR2 553 MHz, M12 connectors and 4GB compact flash with Windows XP Embedded operating system, R40
S12ASR/R/1/32-X-R40	12.1" 1300 cd/m <sup>2</sup> IP67 panel PC with Intel® Atom™ N270 CPU 1.6GHz, 802.11 b/g/n wireless module, touch screen, 1GB DDR2 553 MHz, M12 connectors and 320GB SATA HDD with Windows XP Embedded operating system, R40
S12ASR/R/1/4-L-R40	12.1" 1300 cd/m <sup>2</sup> IP67 panel PC with Intel® Atom™ N270 CPU 1.6GHz, 802.11 b/g/n wireless module, touch screen, 1GB DDR2 553 MHz, M12 connectors and 4GB compact flash with LINUX operating system, R40
S12ASR/R/1/32-L-R40	12.1" 1300 cd/m <sup>2</sup> IP67 panel PC with Intel® Atom™ N270 CPU 1.6GHz, 802.11 b/g/n wireless module, touch screen, 1GB DDR2 553 MHz, M12 connectors and 320GB SATA HDD with LINUX operating system, R40

**Packing List**

Item	Part No.	Description
Panel mount screws pack	44013-030041-RS	
Power cable	32000-127500-RS	2000mm;16AWG; (A) terminal block connector; (B) M12 Waterproof connector
Utilities CD	7B000-000087-RS	
Touch pen	XTR104-0002-RS	
One Key Recovery CD		

**Options**

Item	Part No.
Rack mounting kit	SAILORRK-12
ARM	ARM-11-RS / ARM-31-RS
Stand	STAND-A12-RS / STAND-100-RS

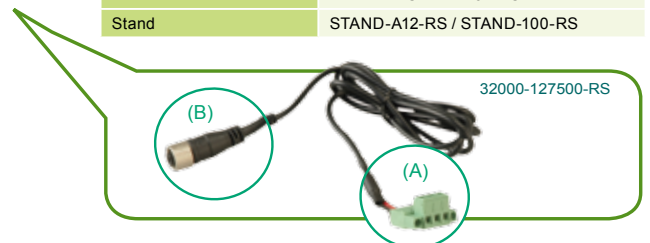

**Optional cables and adapter**

Item	Part No.
USB cable	CB-M12USB02-R10
RJ-45 LAN cable	CB-M12RJ45-R10
DB-9 COM port cable	CB-M12COM-R20
DB-9 CAN-bus and AUDIO line-out cable	CB-M12ACAN-R20
AUDIO line-out cable	CB-M12AUDIO-R10
Water-proof power adapter	63000-CLG6012IC-RS

